



EXPERIMENTAL AND NUMERICAL ANALYSIS OF COLD-FORMED Z-PURLINS

SLIDING CLIP PURLIN/SHEETING CONNECTION

Budapest 2010.02.19

MANSOUR KACHICHIAN
Supervisor: DR. LÁSZLÓ DUNAI

Contents of PhD dissertation

1. Experimental study of purlin/sheeting interaction
2. Effect of sliding clips on purlin/sheeting interaction
3. Full scale load test of purlin/sheeting system
4. Ultimate load test on sheeting
5. Numerical analysis of purlin/sheeting connections

Introduction

1. Structural arrangement and problem statement
2. Purpose of the research
3. Research strategy
4. Experimental program
5. Experimental results
6. Evaluation of results
7. Conclusions

Components

- sliding clip and connection

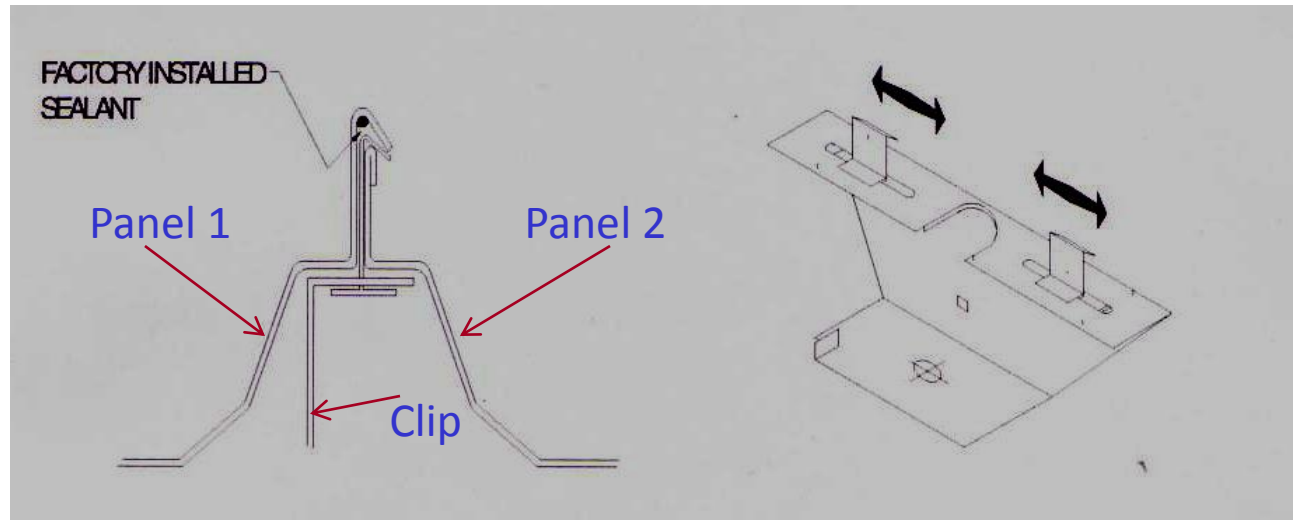

- panel geometry
- material aluminum

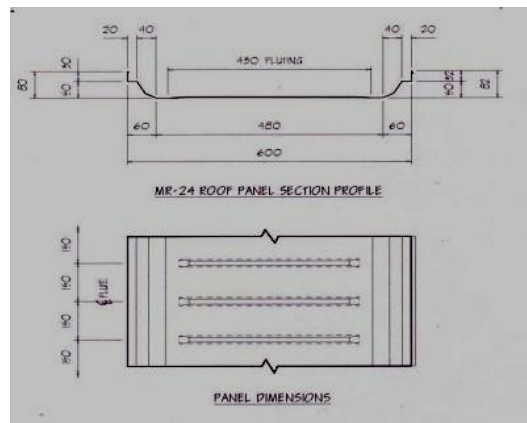

- Z-purlin

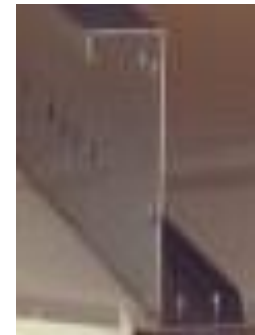

Bridge system

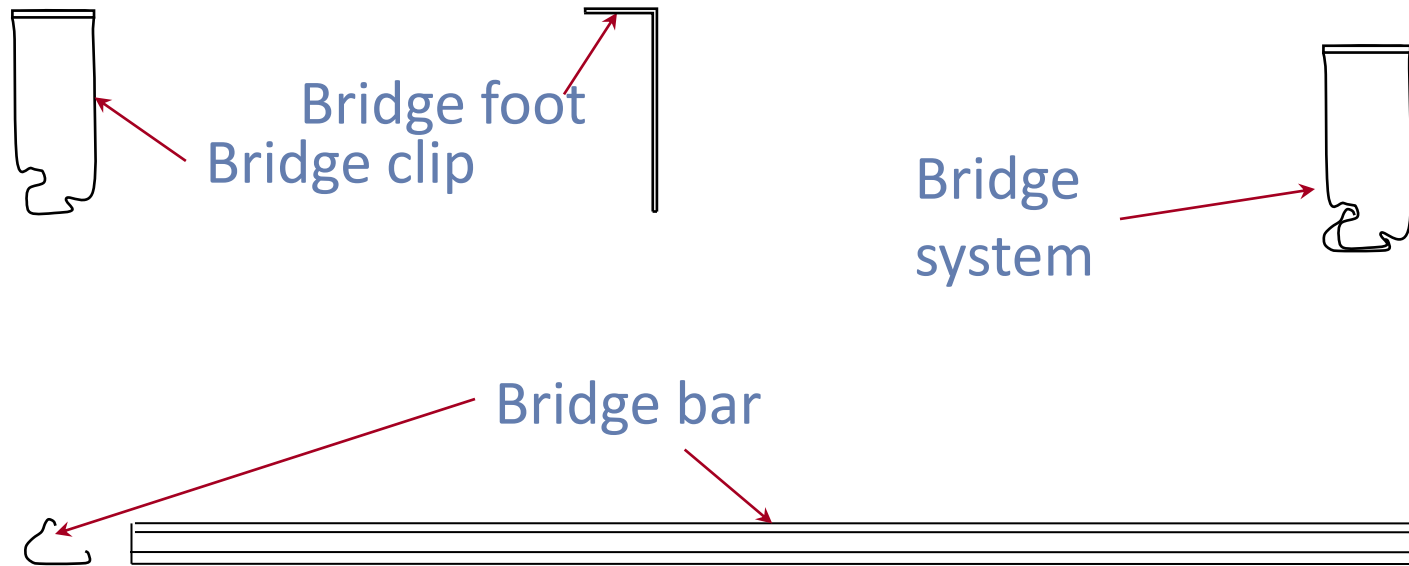

Folding phases of connection

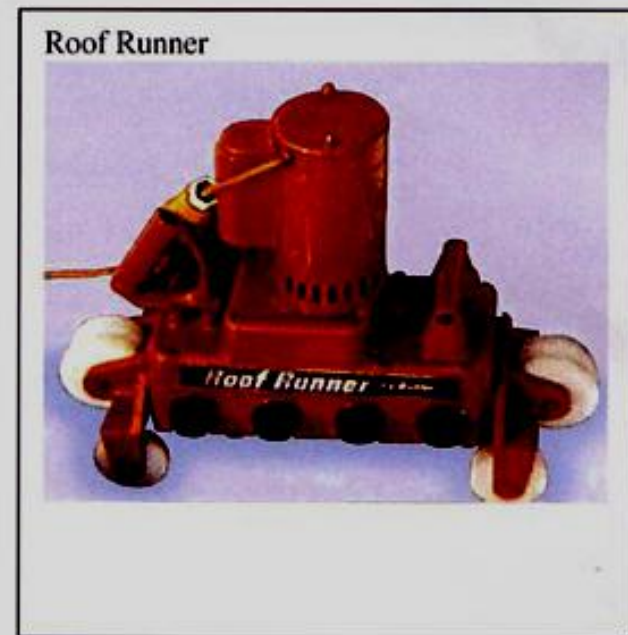
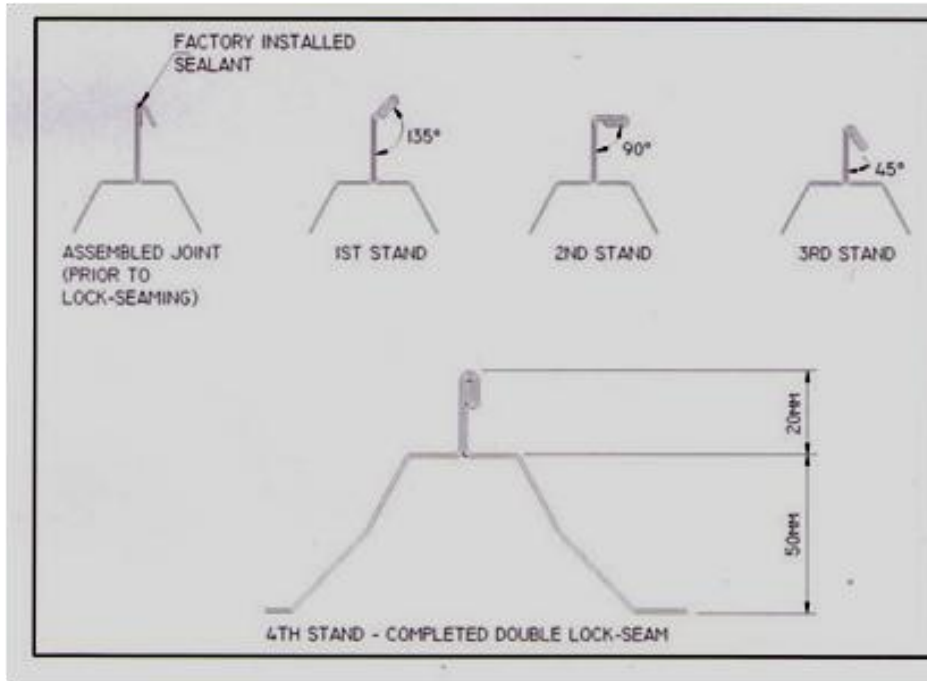

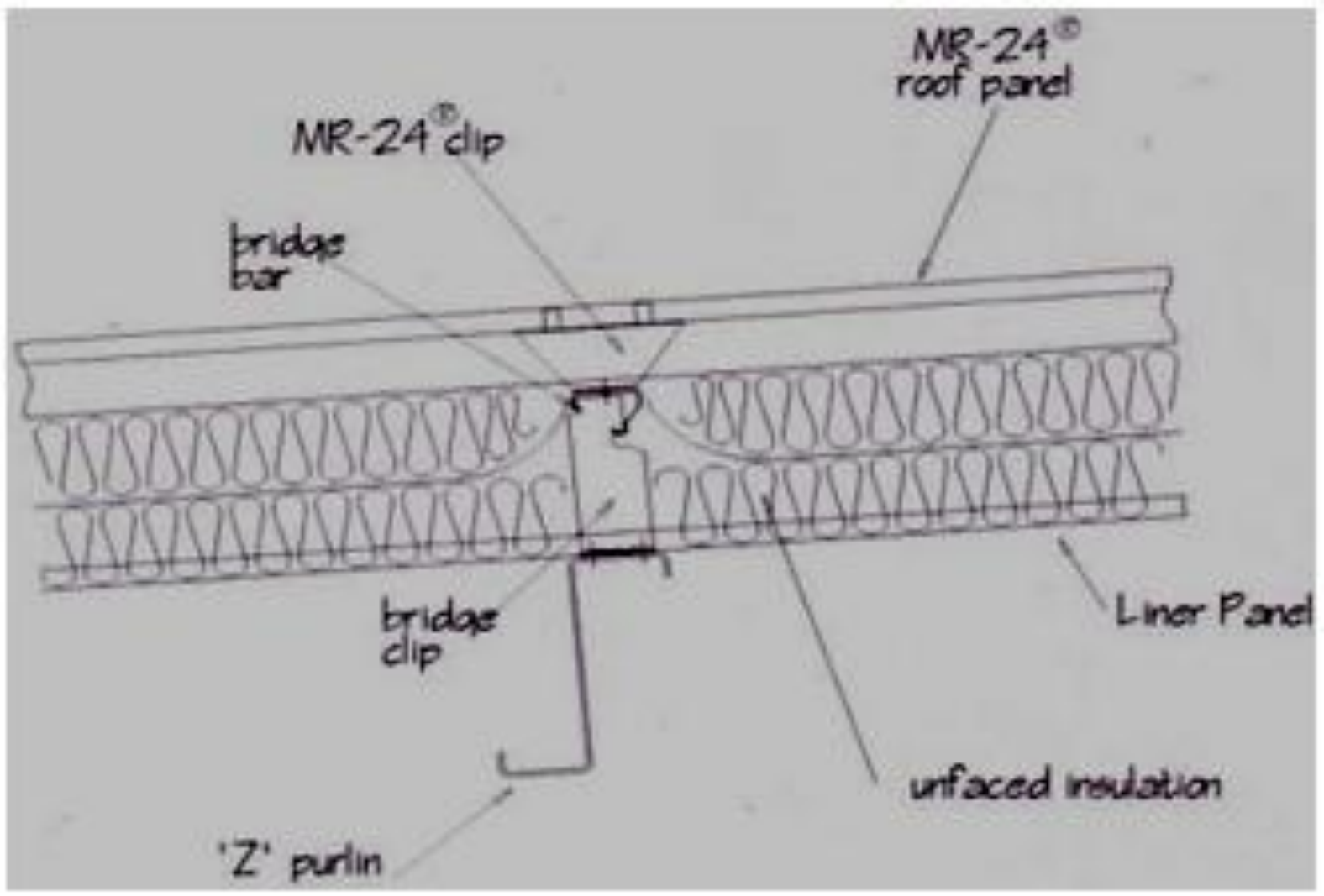



Problem statement and aims

thermal expansion or shrinkage \Rightarrow concentrated stresses
at connections \Rightarrow sliding elements

Sliding elements and bridge system \Rightarrow Purlin lateral support
lateral support + sliding action of elements have significant
effect on the behaviour of the system.



Define the characteristics of system behaviour.

Determine the characteristics of the used elements and
their effect on the lateral stiffness of the system.

Purpose of the experiments

- determine the lateral stiffness of the system
- determine the effect of Z-purlin height
- determine the effect of bridge system
- determine the effect of gravity loads
- determine the effect of lateral load direction

Research strategy

building the test specimens with the supporting, the loading, displacement and measuring systems

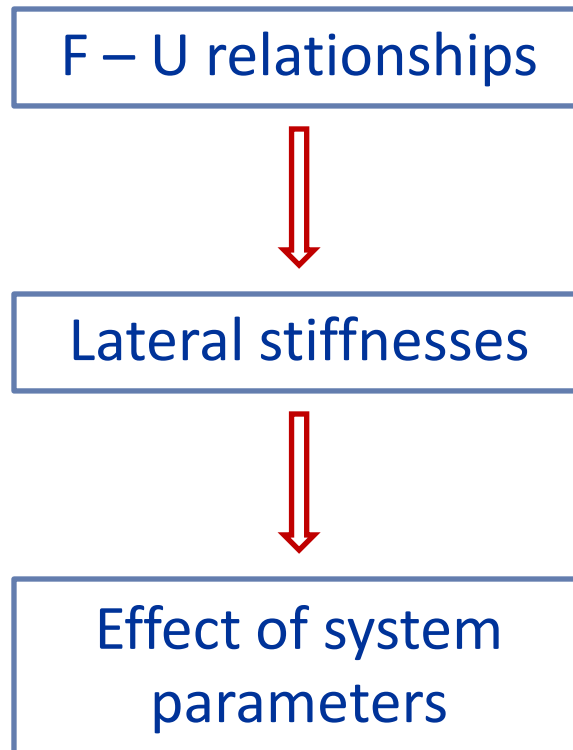

Experimental program

- Test specimens
- Test arrangement
- Loading and measuring system
- Test procedure

Test specimen



Test arrangement

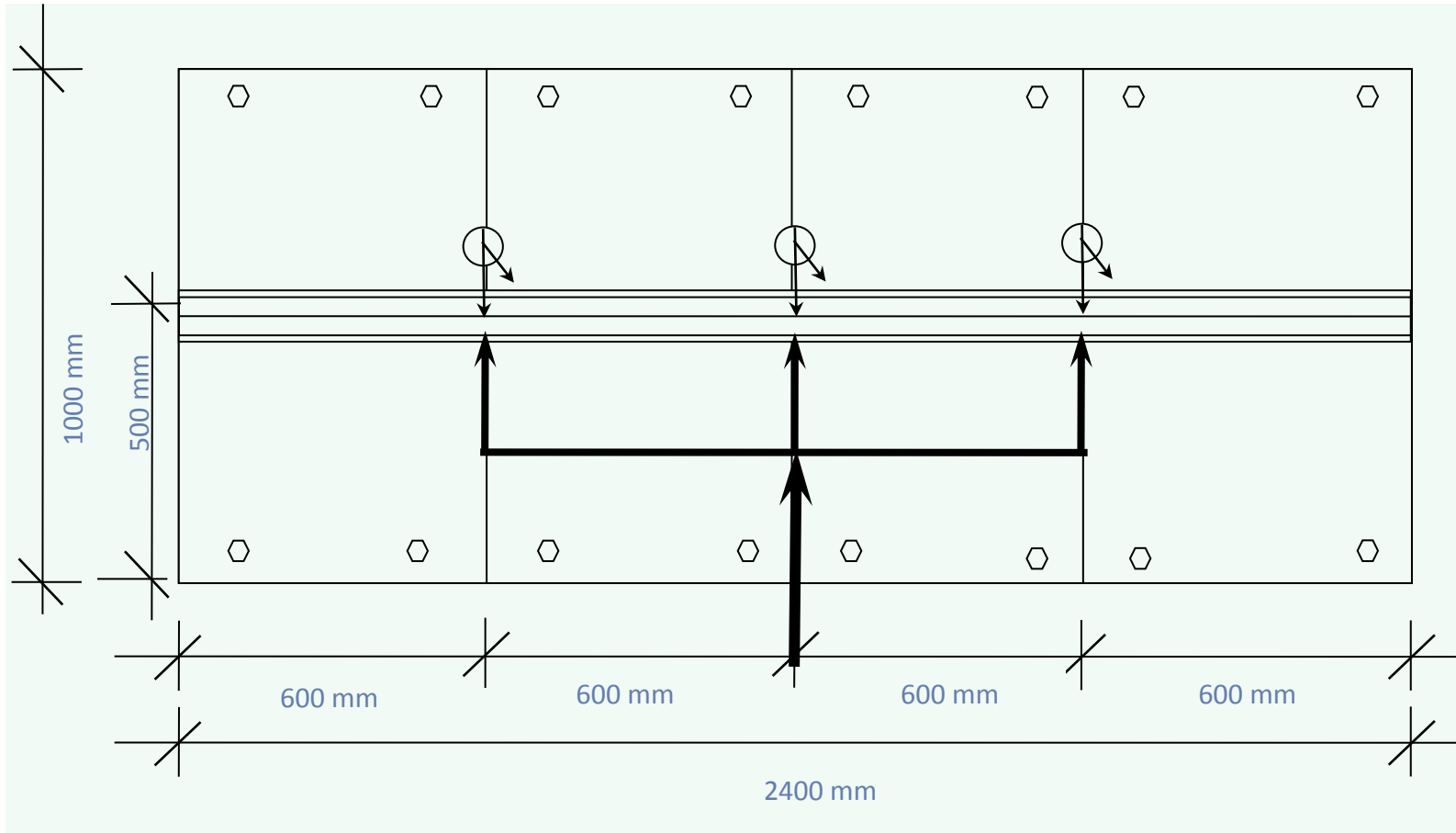

Loading and measuring systems

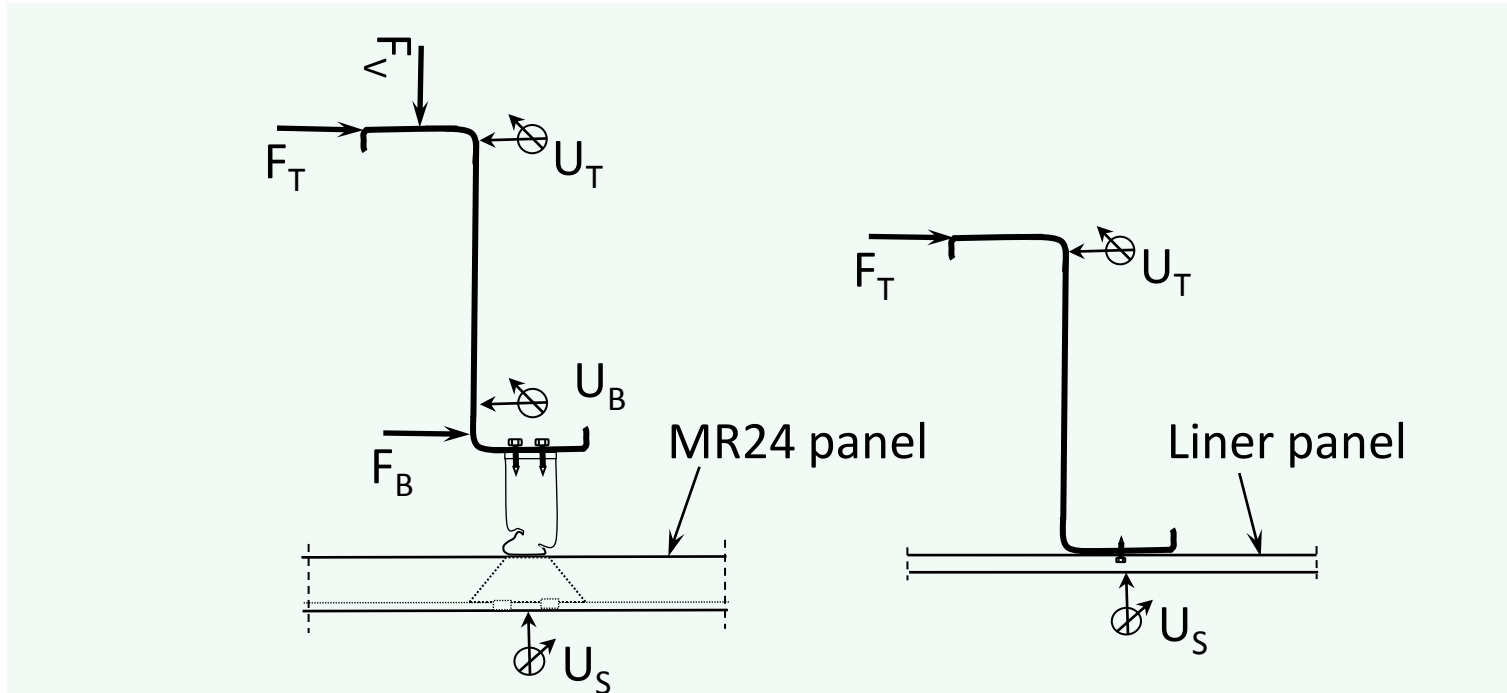

Loading and measuring systems

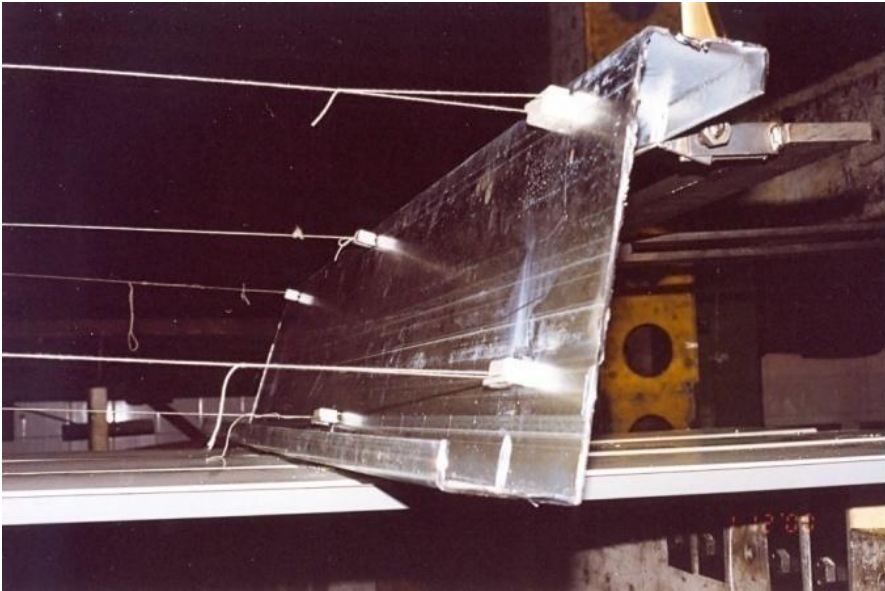

Applied loads

- Mechanically generated lateral load acting at three load points on the top of the upper flange .
- Mechanically generated lateral load acting at three load points at the lower flange level.
- Vertical load with adjustable intensity acting as distributed load at the top of the upper flange to simulate the gravity loads.

Specimen groups

Group 1

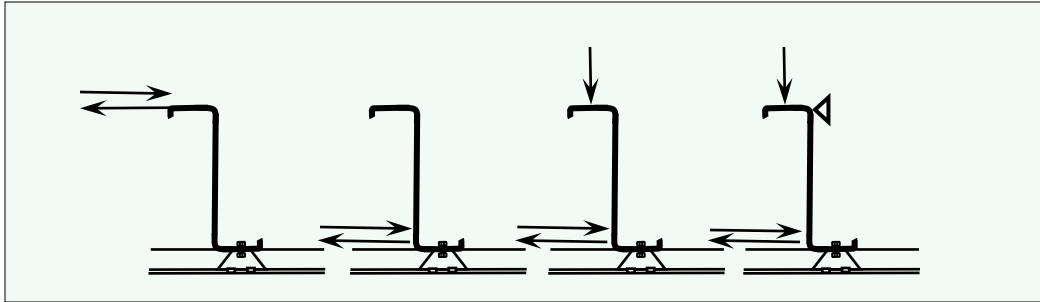

Group 2

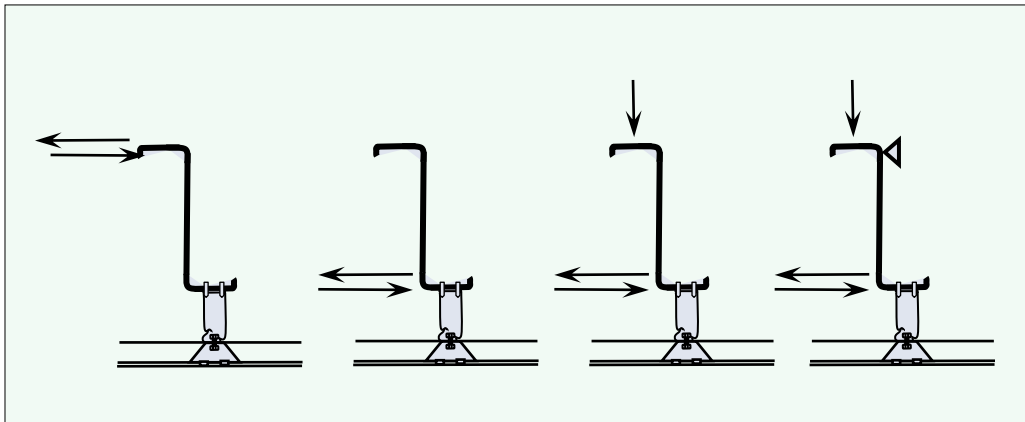

Group 3

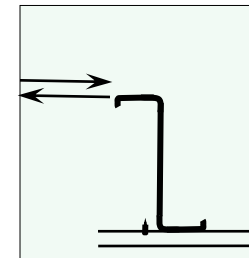

Specimen

components of specimens	specimen code	sheeting panels	sliding clip	heat insulation	bridge system	purlin t=1.5 [mm]
group 1	MR24#1B	MR24	used	used	–	Z–250
	MR24#1A	MR24	used	used	–	Z–200
group 2	MR24#2B	MR24	used	used	used	Z–250
	MR24#2A	MR24	used	used	used	Z–200
group 3	MR24#3B	liner	–	–	–	Z–250
	MR24#3A	liner	–	–	–	Z–200

Specimen

components of specimens	specimen code	sheeting panels	sliding clip	heat insulation	bridge system	purlin t=1.5 [mm]
group 1	MR24#1B	MR24	used	used	–	Z–250
	MR24#1A	MR24	used	used	–	Z–200
group 2	MR24#2B	182 specimens min. 4 ×	–	–	used	Z–250
	MR24#2A		–	–	used	Z–200
group 3	MR24#3B	liner	–	–	–	Z–250
	MR24#3A	liner	–	–	–	Z–200

Testing procedure

lateral loads are applied mechanically.

force magnitude is measured by load cell.

lateral and vertical deformations are measured by inductive transducers

$$F_T \longrightarrow U_T$$

$$F_B \longrightarrow U_B$$

$$F_B + F_V \longrightarrow U_B$$



Experimental results 1

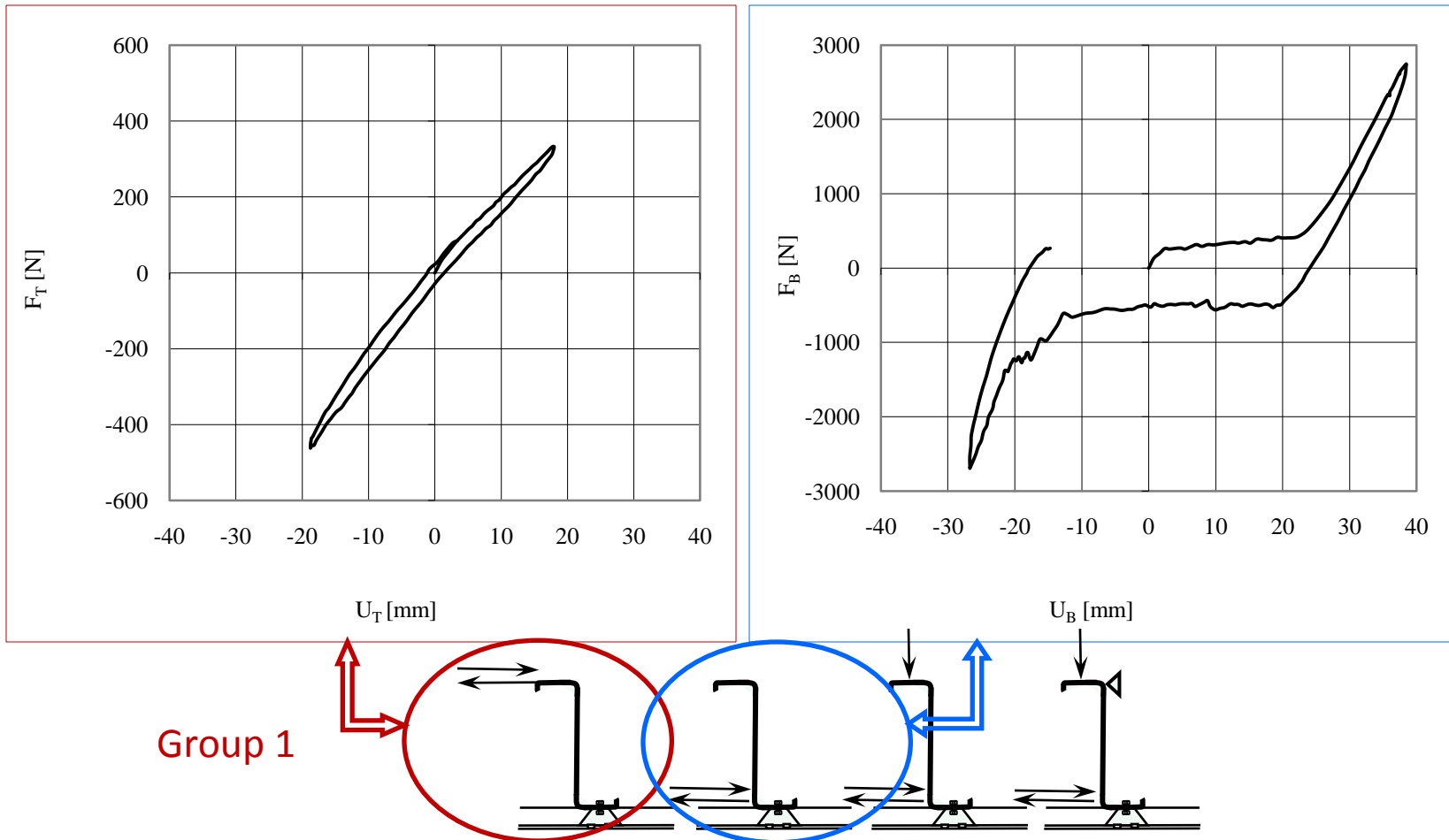

Experimental results 2

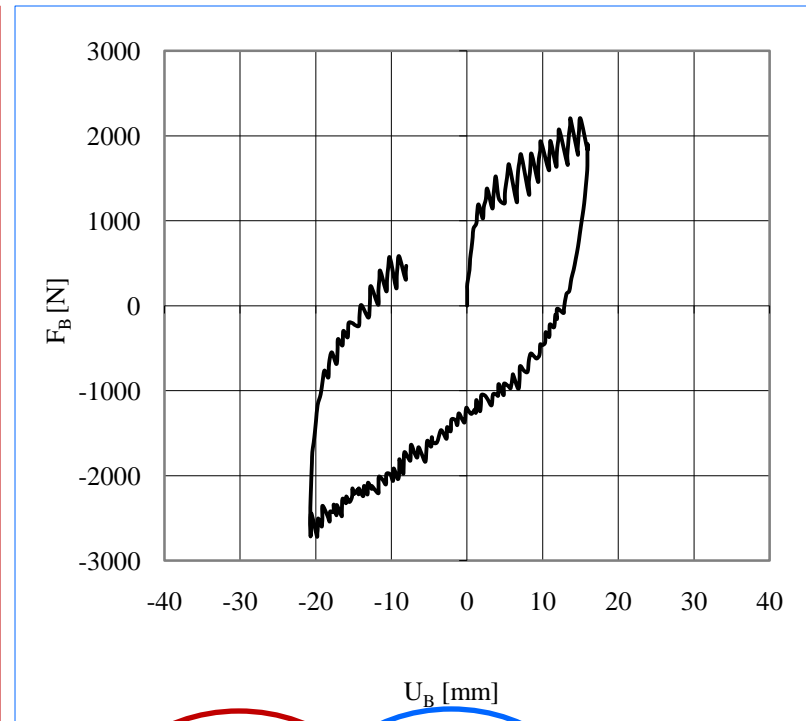
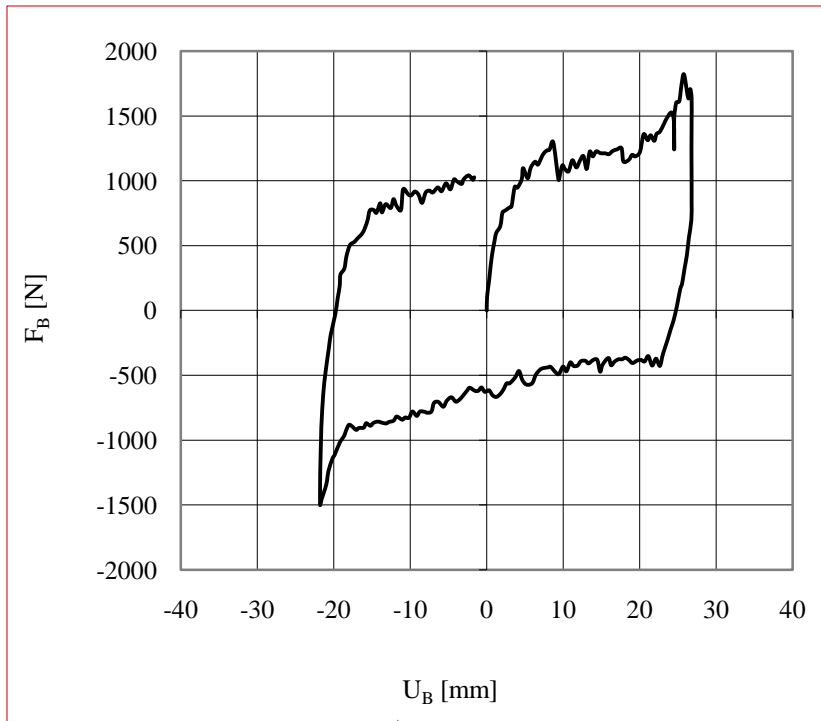

Group 1

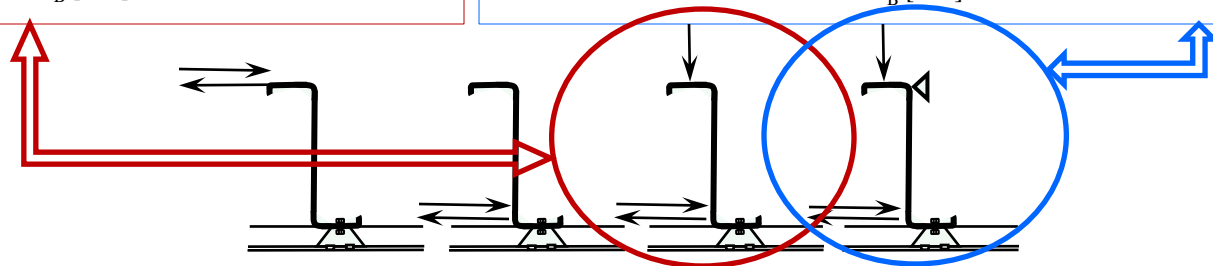

Experimental results 3

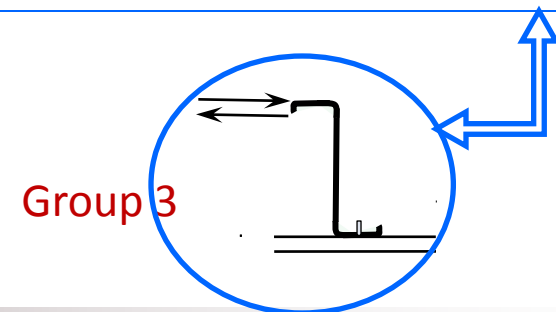
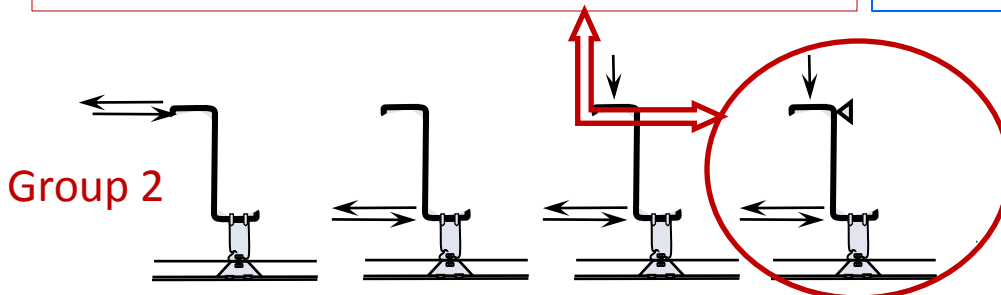
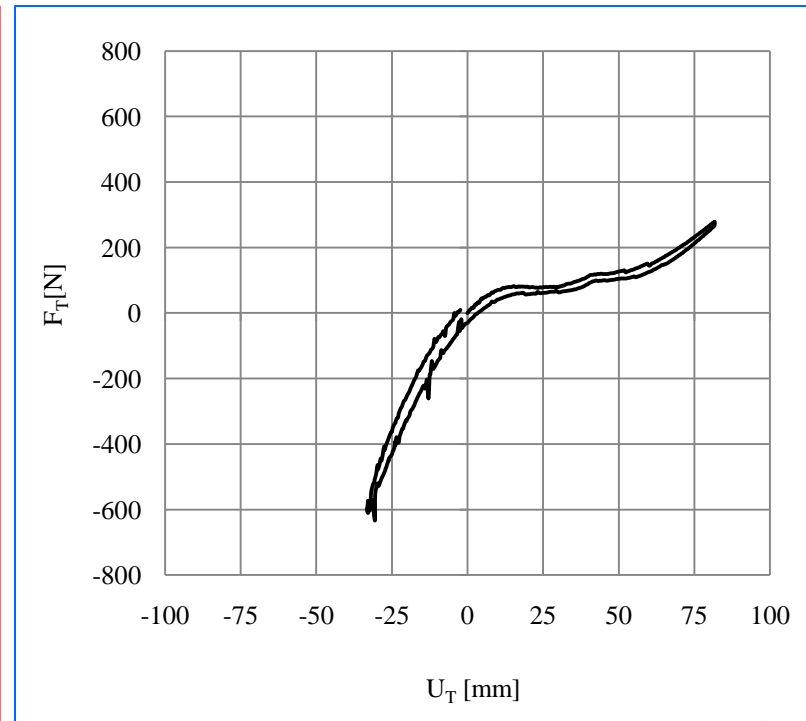
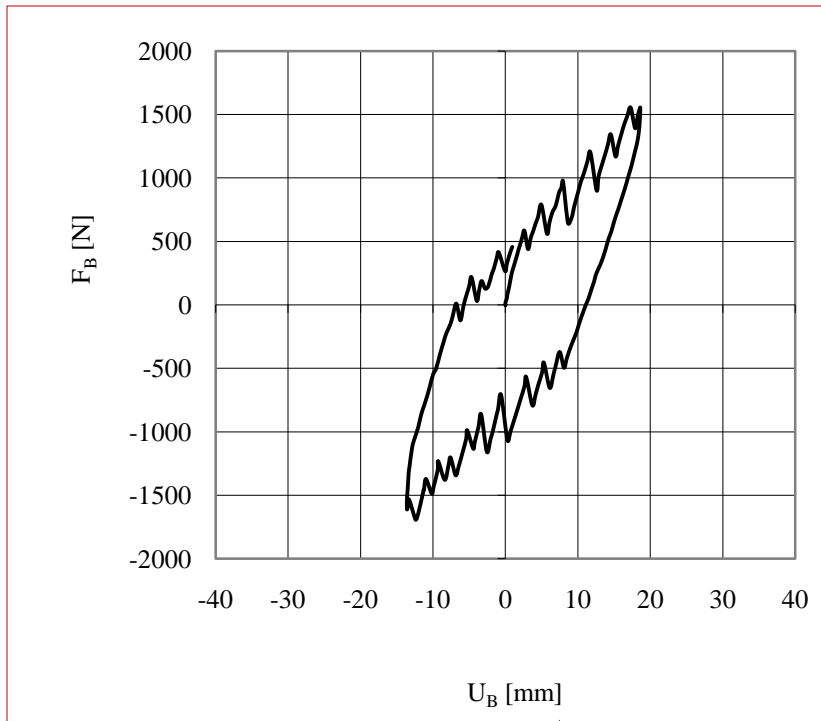

Deformation components

- D_{sh} – MR24 sheeting deformation
- D_{cl} – clip deformation
- D_{br} – bridge deformation
- D_{pu} – purlin deformation

In the tests the effects of D_{sh} and D_{cl} are not significant.

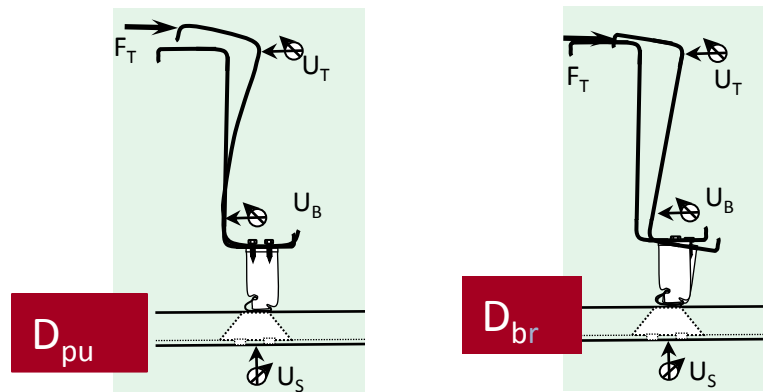

Deformations and sliding types

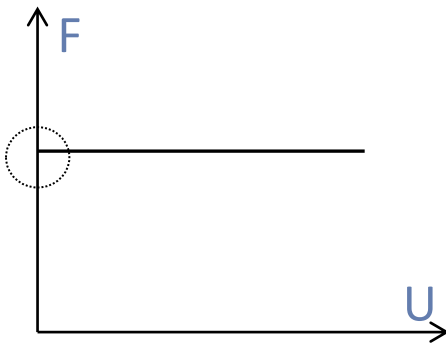

S_{in} – initial slip after the load introduction.

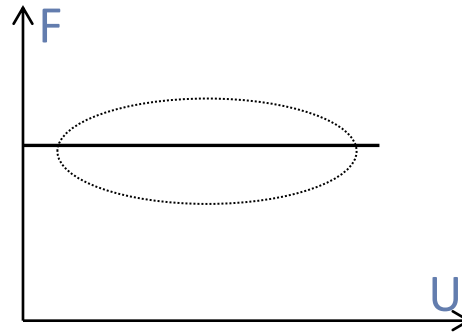

S_{sm} – „smooth” slip after the first slip happened.

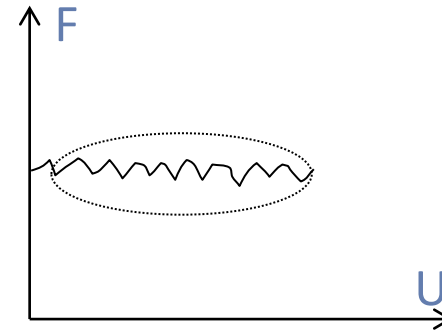

S_{cs} – „continuous” stick–slip after the first slip happened.

Deformations and sliding types

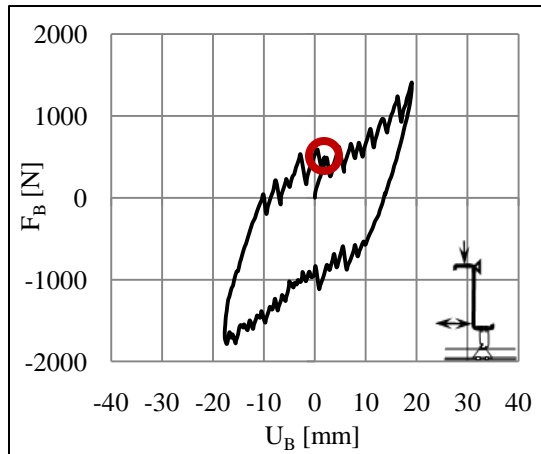

S_{in} – initial slip after the load introduction.

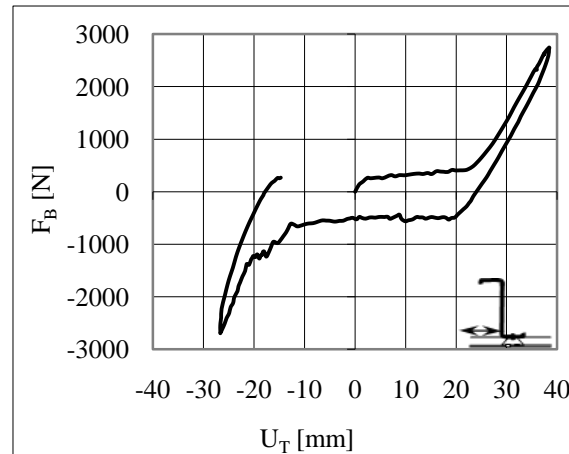

S_{sm} – „smooth” slip after the first slip happened.

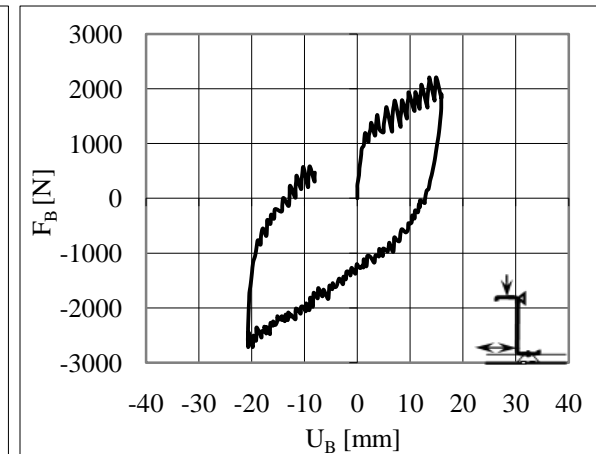

S_{cs} – „continuous” stick-slip after the first slip happened.

Analysis of experimental results

$$F_T - U_T \Longrightarrow K$$

$$F_B - U_B \Longrightarrow K$$

$$\frac{1}{K} = \frac{\delta}{F}$$

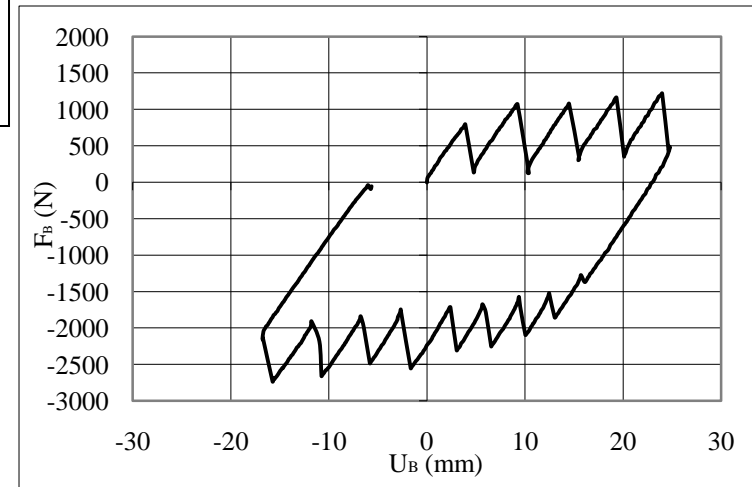
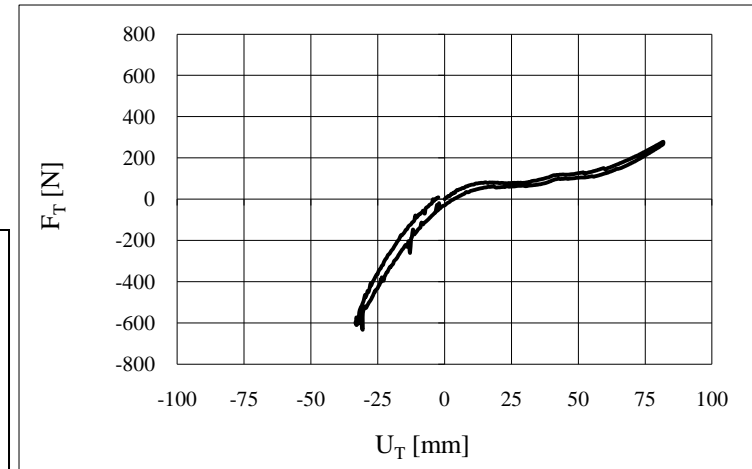
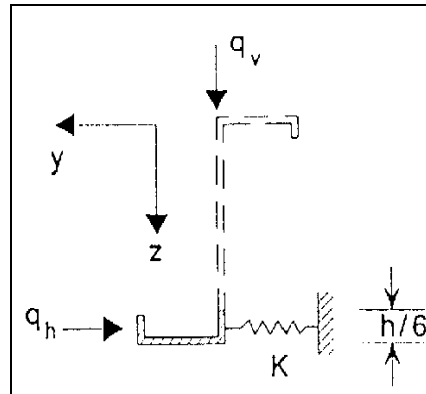

due to the nature of the F–U relationships, two models are developed to calculate the lateral stiffness values

Model #1

- displacements without sliding

$$- K_1 = (F_1/L)/U_1$$

$$- K_4 = (F_4/L)/U_4$$

$$- K_{1(-)} = (F_3 - F_2)/L / (U_3 - U_2)$$

$$- K_3 = (F_5 - F_4)/L / (U_5 - U_4)$$

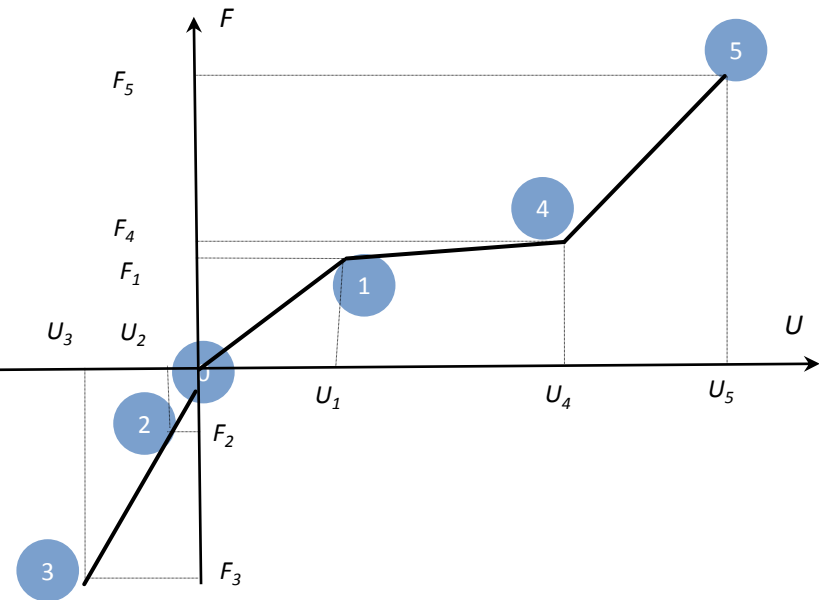
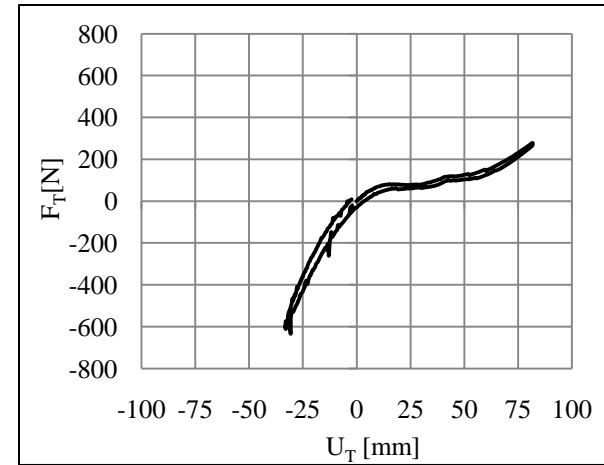

characteristics of Model #1

Model #1 lateral stiffness

average stiffness of the tested specimens

	specimen	purlin	$K_4 \times 100$ [N/mm ²]	$K_{1(-)} \times 100$ [N/mm ²]	$K_3 \times 100$ [N/mm ²]
	MR24#1A	Z200	0.83	0.85	
	MR24#1B	Z250	0.74	0.842	
	MR24#2A	Z200	0.143	0.143	
	MR24#2B	Z250	0.061	0.124	
	MR24#3A	Z200	0.352	1.478	0.389
	MR24#3B	Z250	0.176	0.635	0.294

Model #2

K_1 average elastic lateral stiffness of the system

K_2 friction/sliding stiffness of the system including nonlinear behaviours and sliding effects

F_f average initialing friction/sliding load at which sliding behaviours occurs

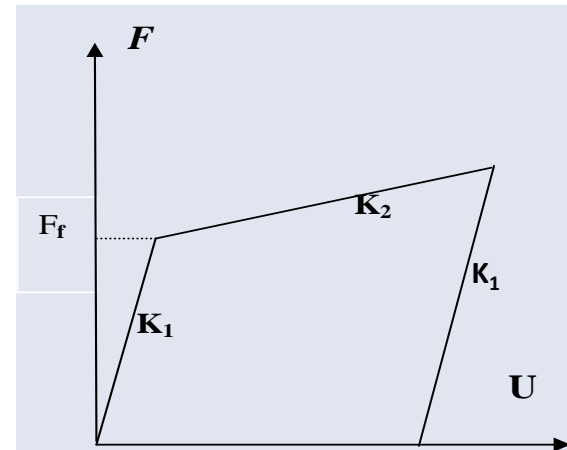
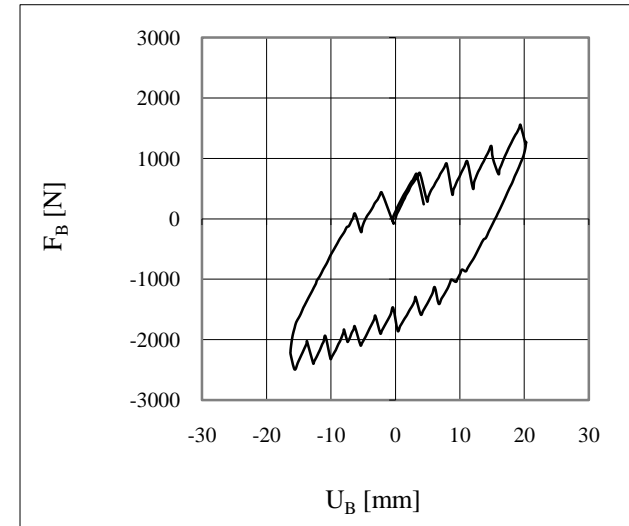

characteristics of Model #2

Parameters of Model #2

$$K_1 = (k_{11} + k_{12} + k_{13}) / 3$$

$$K_{11} = (F_{\min} / L) / U_{\min}$$

$$K_{12} = (F_3 - F_4) / L / (U_3 - U_4)$$

$$K_{13} = (F_1 - F_2) / L / (U_1 - U_2)$$

$$K_2 = (F_{\max} - F_{\min}) / L / (U_{\max} - U_{\min})$$

$$F_f = ((F_{T1} - F_{T2}) + (F_{T3} - F_{T4})) / 4$$

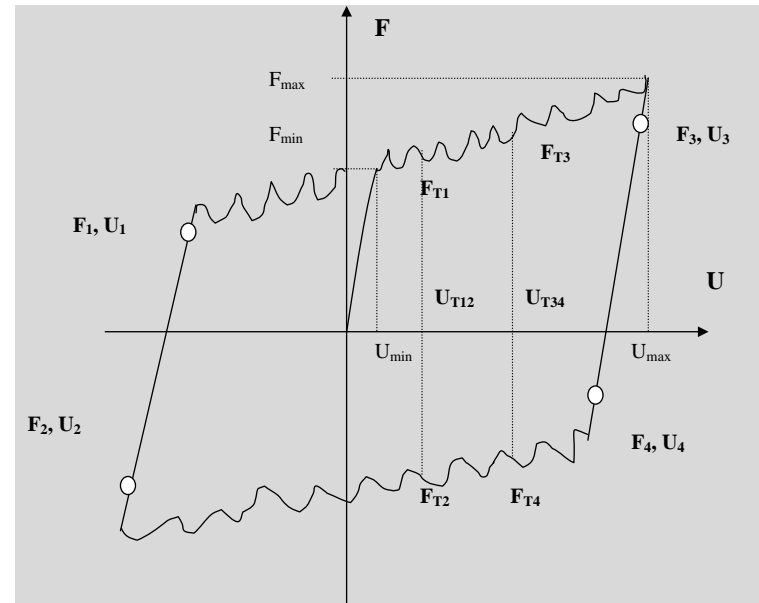

Model # 2 parameters

Model #2

initial stiffness $K_1 \times 100$ [N/mm²]

upper flange condition	F_V [N]				
		Z-200	Z-200	Z-250	Z-250
	0	0.164	0.009	0.1	0.005
	662	0.247	0.003	0.067	0.011
	1709	0.275	0.004	0.176	0.022
	2308	0.329	–	0.162	–
	662	0.269	0.08	0.226	0.064
	1709	0.263	0.09	0.187	0.07
	2308	0.306	0.085	0.196	0.077
	2907	0.311	0.085	0.38	0.079

Model #2

friction sliding stiffness $K_2 \times 100$ [N/mm²]

upper flange condition	F_V [N]				
		Z-200	Z-200	Z-250	Z-250
	0	0.003	0.0014	0.0025	–
	662	0.01	0.0003	0.0028	0.0058
	1709	0.014	0.0013	0.0115	0.0128
	2308	0.018	–	0.0094	–
	662	0.054	0.0219	0.0353	0.0103
	1709	0.044	0.0169	0.0346	0.003
	2308	0.051	0.0145	0.0406	0.0135
	2907	0.058	0.0147	0.034	0.0073

Model #2

friction sliding force $2F_f$ [N]

upper flange condition	F_v [N]				
		Z-200	Z-200	Z-250	Z-250
	0	1072	–	859	–
	662	1430	169	458	–
	1709	1812	–	1573	–
	2308	1978	–	1900	–
	662	2140	1314	1298	1580
	1709	2083	2121	1693	2128
	2308	2141	2524	1888	2459
	2907	2713	3011	2080	3044

Evaluation of results

- lateral load at top flange
- lateral load at bottom flange

Lateral load at top flange

- purlin height effect on specimen stiffness:
Z-250/ Z-200 \implies 40-90 %
- bridge system effect on specimen stiffness:
with bridge/without bridge \implies 10-15 %
- direction of load effect on specimen stiffness:
Positive/negative load \implies 25-100 %

Lateral load at bottom flange

- the effect of high bridge system is significant on the lateral stiffness $K_1 \implies 1-40 \%$
 $K_2 \implies 5-50 \%$
 $F_f \implies 60-100 \%$
- gravity load has significant effect as well
 $\implies 5-100 \%$
- purlin height and restraint of the purlin upper flange have smaller effect compared to the previous two parameters $\implies 30-90 \%$



Conclusions

1. I designed a test procedure to test cladding systems with sliding and bridge elements; I completed tests on 182 specimens.
2. I analyzed the test results on the basis of F-U relationships for specimens and determined the typical behaviour modes.
3. On the basis of the test results I developed two models to characterize the observed behaviour.
4. The models are used for stability design of purlins:
 - (i) lateral stiffness values are built in the design method of purlins.
 - (ii) the insufficient structural arrangements are determined.



Thank you